

# Microwave Oven

Model: HIL 2810EGCB

Owner's Manual

# Haier

*Please read this booklet carefully before fixing and using and  
save it for future reference.*

## OPERATION THEORY OF MICROWAVE OVEN

1. Microwave is a kind of high frequency electromagnetic wave, which is commonly distributed in the nature. But the existing form of microwave is dispersed so that it cannot be collected together for heating purpose. The key component of magnetron of microwave oven will transform the energy of electricity to microwave and huge energy of microwave field is established under the closed cavity. So the molecule of food is caused to vibrate at very high speed and the friction heat produced will cook the food in a fast way.

2. There is 3 properties of microwave, that is

a) Absorbability: the microwave can cause the excess vibration of molecule of various food so as to obtain the heating purpose. But the infiltration ability is largely depend on the size, thickness and properties of the food.

b) Penetrability: microwave can penetrate through ceramics, glass, temperature-resistant plastics. It is required to use the containers whose material have good microwave penetrability to achieve best heating result. Please see the below utensils guide.

c) Reflectivity: microwave would be reflected by the metal wall of interior cavity so as to establish an even magnetic field, thus can prevent the overheating of partial area.

## INSTALLATION OF MICROWAVE OVEN

1) To ensure sufficient ventilation, the distance of the back of microwave to the wall should be at least 10 cm, the side to the wall should be at least 5cm, the free distance above the top surface at least 20 cm.

2) The appliance should be operated with the rear side placed against a wall.

3) Do not place any objects on the top of microwave oven.

4) The position of the oven shall be such that it is far from the TV, Radio or antenna as picture disturbance or noise may occur.

5) The appliance must be positioned so that the plug is accessible.

6) The microwave oven is intended to be used freestanding and shall not be placed in a cabinet.

7) To keep the microwave oven at a distance from the wall, it is necessary to install a distance limiter.

8) 15amp power plug to be used

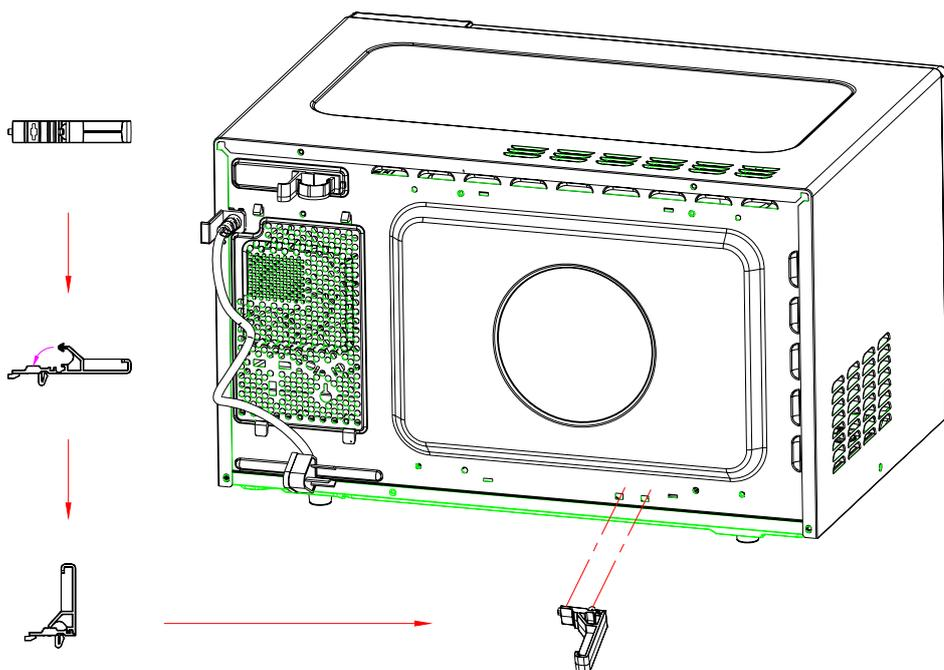

## UTENSILS GUIDELINE

It is strongly recommended to use the containers which are suitable and safe for microwave cooking. Generally speaking, the containers which are made of heat-resistant ceramic, glass or plastic are suitable for microwave cooking. Never use the metal containers for microwave cooking **and combination cooking** as spark is likely to occur. You can take the reference of below table.

Material of container	microwave	Grill	Combi	Notes
Heat-resistant ceramic	Yes	No	No	Never use the ceramics which are decorated with metal rim or glazed
Heat-resistant plastic	Yes	No	No	Can not be used for long time microwave cooking
Heat-resistant glass	Yes	No	No	
Grill rack	No	Yes	Yes	
Plastic film	Yes	No	No	It should not be used when cooking meat or chops as overtemperature may do damage to the film

## FOR THE FIRST USE

As there is manufacturing residue or oil remained on the oven cavity **or heat element**, it usually would smell the odor, even a slight smoke, It is normal case and would not occur after several times use, keep the door or window open to ensure good ventilation. So it is strongly recommended to set the oven to grill mode and operate dry several times. Operating dry can only be conducted in the grill mode, it can not be conducted at combination mode

## IMPORTANT SAFEGUARDS

The following basic precautions should always be followed when using electrical appliance:

1. Read all instructions before using.
2. Make sure the voltage in your living area corresponding to the one shown on the rating label of the appliance. And the wall socket is properly grounded.
3. To reduce the risk of fire in the oven cavity:
  - a. Do not overcook the food.
  - b. Remove wire twist-ties from paper or plastic bags before placing bags in the oven.
  - c. Do not heat oil or fat for deep frying as the temperature of oil cannot be controlled.
  - d. After use wipe the waveguide cover with a damp cloth, followed by dry cloth to remove any food splashes and grease. Built-up grease may overheat and begin to cause smoke or catch fire.
  - e. If materials inside the oven should smoke or ignite, keep oven door closed, turn oven off and disconnect the power supply.
  - f. Close supervision is necessary when using disposable containers made from plastic, paper or other combustible material.
4. To reduce the risk of explosion and sudden boiling:
  - a. Do not place sealed containers in the oven. Baby bottles fitted with a screw cap or teat are considered to be sealed containers.
  - b. When boiling liquid in the oven, use the wide-mouthed container and stand about 20 seconds at the end of cooking to avoid delayed eruptive boiling of liquids.
  - c. Potatoes, sausage and chestnut should be peeled or pierced before cooking. Eggs in their shell, whole hard-boiled eggs should not be heated in microwave ovens since they may explode, even after microwave heating has ended.

- d. The cooked eggs or liquid should not be removed out immediately. Several moments should be waited before removing In order to avoid possible hazards caused by delayed eruptive boiling of liquids.
- e. The contents of feeding bottles and baby food jars are to be stirred or shaken and the temperature is to be checked before consumption, in order to avoid burns.
5. Never operate the oven further if the door or door seals are damaged or the oven is malfunctioned or supply cord is damaged. Return the appliance to the nearest authorised service center for repair and maintenance. Never try to adjust or repair the oven yourself.
6. If the supply cord is damaged it must be replaced by the manufacturer or its service agent or a qualified technician in order to avoid a shock hazard.
7. After cooking, the container is very hot. Using gloves to take out the food and avoid steam burns by directing steam away from the face and hands.
8. Slowly lift the furthest edge of dishes cover and microwave plastic wrap and carefully open popcorn and oven cooking bags away from the face.
9. To prevent the turntable from breaking:
  - a. Let the turntable cool down before cleaning.
  - b. Do not place hot foods or utensils on the cold turntable.
  - c. Do not place frozen foods or utensils on the hot turntable.
10. Make sure the utensils do not touch the interior walls during cooking.
11. Failure to maintain the oven in a clean condition could lead to deterioration of the surface that could adversely affect the life of the appliance and possibly result in a hazardous situation.
12. Only use utensils that are suitable for use in microwave ovens.
13. Do not store food or any other things inside the oven.
14. Do not operate the oven without any liquid or food inside the oven. This would do damage the oven.
15. This appliance is not intended for using by young children or infirm persons without supervision.
16. When the appliance is operated in the combination mode, children should only use the oven under adult supervision due to the temperatures generated.
17. Any accessories not recommended by the manufacturer may cause injuries to persons.
18. Do not use outdoors.
19. Save these instructions.
20. This appliance is not intended for used by persons (including children) with reduced physical, sensory or mental capabilities, or lack of experience and knowledge, unless they have been given supervision or instruction concerning use of the appliances by a person responsible for their safety.  
Children should be supervised to ensure that they do not play with the appliance.
21. The appliance is not intended to be controlled by an external timer or separate remote-control system

## **Household use only**

# PRODUCT INTRODUCTION

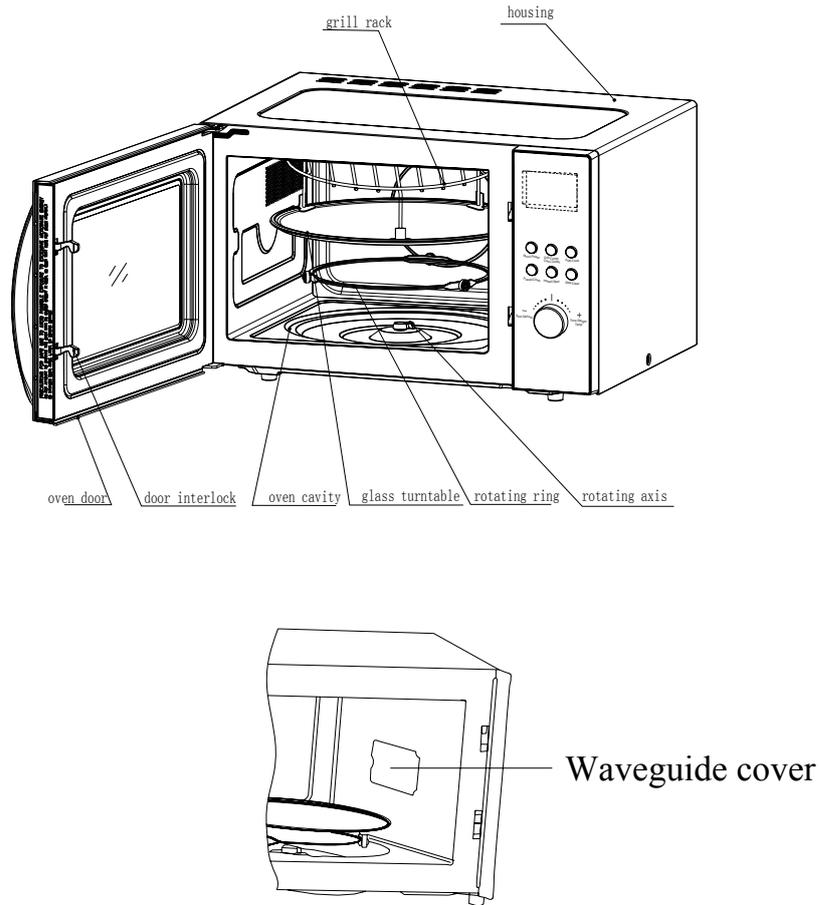
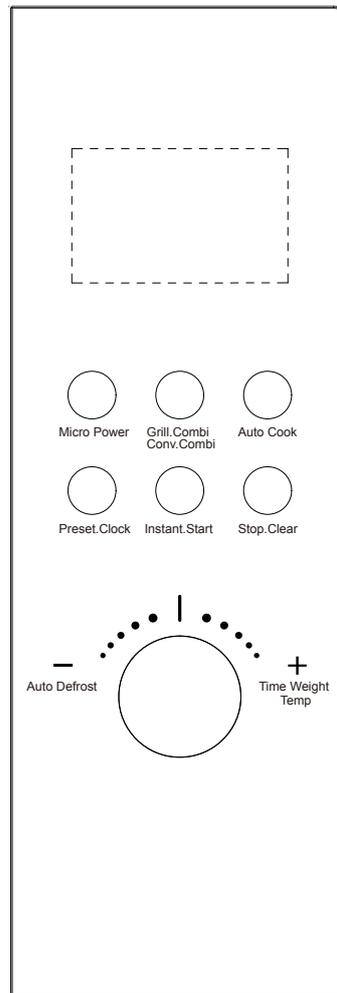

**Fig.1**

## Notes:

1. Door interlock ensures the oven can only be activated when the door is properly closed, which would prevent microwave radiation.
2. Control panel is illustrated in next page (the control panel is subject to change without prior notice).
3. Do not remove the Waveguide cover during cleaning (see Fig.1).
4. Glass turntable turns to make food are heated evenly.
5. Grill rack is used to place the roasting food
6. LCD will show the clock time, cooking mode and left operation time, which depends on the current set mode.

# OPERATION OF CONTROL PANEL



## **1. Before cooking**

The LCD will flash  3 times when plugged in power supply. Then it will flash :, prompting you to input the cooking menu and time.

## **2. Time. weight/Auto cooking knob**

You can select auto cooking menu and increase or decrease cooking time and weight during operation by turning **Time. Weight/ Auto cooking** knob.

## **3. Stop/Clear**

At the initial or input stage: press once to cancel input programs and resume initial stage.

During cooking: press once to stop oven operation, press twice to cancel cooking programs.

## **4. Auto reminder**

When your preset cooking procedure have finished, the LCD Display will show **End** and three beeps sound will be heard to prompt you to take out food. If you do not press **Stop/ Clear** button once or open the door the beep will be sounded at an interval of 3 minutes.

## **5. Child lock function**

Use this feature to lock the control panel when you are cleaning or so that children can not use the oven unsupervised. . All the buttons are rendered inoperable in this mode.

To set child lock, depress and hold **Stop/ Clear** button about 3 seconds until LCD appears **OFF**.

To cancel child lock, depress and hold **Stop/ Clear** button about 3 seconds until LCD appears colon.

### **6.Microwave cooking**

Press Micro Power button, LCD will cycle to show 100P 80P 60P 40P 20P

100P--- High power, 100% microwave power.

Applicable for quick and thorough cooking, such as meat, vegetable

80P --- Medium High power, 80% microwave power. Applicable for medium express cooking, such as eggs, fish, congee, rice, soup

60P --- Medium power, 60% microwave power. Applicable for steaming food

40 P --- Medium Low power, 40% microwave power. Applicable for defrosting food

20P --- Low power, 20% microwave power. Applicable for keeping warm

NOTE:

1) The max time which can be set is 60 minutes and 00 seconds.

2) Never use the Grill rack during microwave cooking.

3) Never operate the oven empty.

4) If you turn the food during operation, press the Instant. Start button once and the preset cooking procedure will continue.

5) If you intend to remove the food before the preset time, you must press Stop. Cancel button once to clear the preset procedure to avoid unintended operation of next time use.

Depress	Display
Example: To cook at 80P for 10 minutes.	
1. After power-up, the colon flashes or press <b>Stop/Clear</b> button once	
2. Select the desired microwave power by depressing <b>Micro Power</b> button consecutively	
3. Set the cooking time by turning the <b>Time. weight/ Auto cooking</b> knob	
4. Press <b>Instant/Start</b> to start, and LCD will count down to show running time.	
You may change the cooking time during cooking. And it is recommend to turn the food halfway, after you turn the food. Press <b>Instant/Start</b> button once to...	

## 7. Convection/Combination Grill/Combination

Press this button LCD Display will cycle to show C...C.1...C.2...G...G.1...G.2

### A) Convection/Combination

C---Convection, convection unit will be energized during entire operation time. In this mode, hot air is circulated throughout the oven cavity to brown and crisp foods quickly and evenly.

C.1 --- Combination of convection and microwave cooking. The combination of these two cooking methods produces juicy meats, as well as tender poultry, with the right browning and crispness. Meats and poultry are best when cooked directly on the rack. A shallow dish can be placed below the food if gravy is to drop.

C.2 --- Same as above C1, except more microwave cooking time. This is suitable for cooking large size poultry utilizing the penetration ability of microwave.

### Temperature setting

Select operating temperature by different task, Temperature includes 100°C, 140°C, 180°C, 200°C and 230°C.

For defrosting, set at 100°C.

For baking, set the oven at 140°C or 180°C.

For grill poultry, set at 180-230°C.

In combination mode, the cooking temperature you set can't exceed 180°C as the oven cannot be heated to the temperature higher than 180°C.

### Preheating

1. In the convection mode, preheating is usually required so as to obtain best result. But preheating is not recommended to use in combination mode.

2. The preheating temperature must be always higher than oven temperature. For instance, the oven has been operated at 230°C, then you would like the oven to be operated at 180°C, in this case LCD displays Err2. You must reset the temperature or wait the oven to cool down.

Notes:

1. The oven should not be used without the turntable in place, and the turntable should never be restricted otherwise it cannot rotate. You may remove the turntable when preheating the oven.

Example: To cook with convection function  at 180°C for 20 minutes

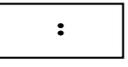
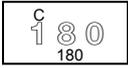
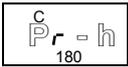
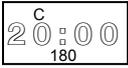
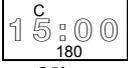
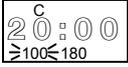
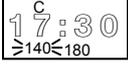
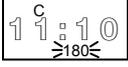
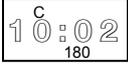
Depress	Display
1. After power-up, the colon flashes or press <b>pause cancel</b> button once	
2. Press <b>Conv. Combi/Grill. Combi</b> button consecutively to select desired menu	
3. Select convection temperature by turning <b>Auto. Defrost+</b> or <b>Weight/Temp. Time-</b> knob	
4. Press <b>Instant. Start</b> button confirm it	
5. Set cooking time or preheating time. In most case the oven has to be preheated to preset temperature before placing food in order to achieve best result. turn <b>Auto. Defrost</b> or <b>Weight/Temp. Time</b> knob to set the cooking time <b>Or</b> you may skip this step The oven would be well heated within the Default preheating time-15 minutes	
6. Press <b>Instant. Start</b> button start cooking	 <b>or</b> 
7. The temperature is rising constantly during preheating period and LED will show as follows while temperature changes The oven will be heated from 100°C. Once the oven has reached the 100°C will go steady and the oven temperature is approaching 140°C... Once the oven has reached the 180°C the numbers will go steady and the preheating process can be considered terminated.	 :  
8. When cooking program is ended, the integrated cooling fan will automatically start running for 30 seconds while the lamp is illuminated. This is intended to prolong the lifetime of electronic part.	

2. Do not cover turntable or rack with aluminum foil. It interferes with air flow so as to slow down the cooking speed.
3. Round pizza pans are excellent cooking utensils for many convection-only items. Choose pans that do not have extended handles.
4. Check for doneness after time has elapsed. If not completely done, let stand in oven a few minutes to complete cooking.

Convection cooking example:

Task	Weight/dimension	Cook temperature	Preheating	Cooking time
grilling poultry,	1.5kgchicken	230°C	Yes	45 minutes
making cake,	20cm in diameter	180°C	Yes	45 minutes
making cookies,	25 pieces cookies	180°C	Yes	20 minutes
Baking pizza	15mm thickness	200°C	Yes	30 minutes

The examples described in the above are just used for reference, you can change cooking temperature, time by yourself depending on the food type, weight, your cooking experience and your favour taste.

### B) Grill/combination

Press this button LCD will cycle to show G, G.1, G.2.

G--- Grill, the heat element will be energized during operation time. Which is applicable for grilling thin meats or pork, sausage, chicken wing as good brown color can be obtained.

G.1--- Combination of Grill and microwave cooking. Heat element and magnetron is energized in an alternate way. Utilizing the properties of microwave penetration thick food is suggested to cook in this mode, as the center of food can be done and brown crust still can be obtained.

G.2--- Same as G1 except more microwave cooking time. Applicable for thick meats, chicken, drumsticks, the inside can be done and brown crust color can still be obtained on the outside.

Note: it is not necessary to preheat for grill cooking.

Warning:

In the mode of grill/combi of the oven parts, as well as the rack and cooking containers, may become very hot. Use caution when removing any item from the oven. Use heavy potholders or oven mitts to PREVENT BURNS.

Depress	Display
Example: To grill food with G.2 for 10 minutes	
1. After power-up, the colon flashes or press <b>Stop/Clear</b> button once	:
2. Select the desired cooking menu by pressing <b>Grill/Combi</b> button	G . 2 GRILL
3. Set the cooking time by turning the <b>Time. Weight /Auto cooking</b> knob	1 0 : 0 0
4. Press <b>Instant/Start</b> to start, and LED will LCDcount down to show running time.	

## 8. Auto defrost

Press the button and the LCD display will circle to show d.1 d.2 d.3.

d.1 --- for defrosting meat, the weight range from 0.1Kg to 2.0 Kg.

d.2 --- for defrosting poultry, the weight range from 0.2 to 3.0Kg.

d.3 --- for defrosting seafood, the weight range from 0.1 to 0.9Kg.

Note:

1. It is necessary to turn over the food during operation to obtain uniform effect.

2. Usually defrosting will need longer time than that of cooking the food.

3. If the food can be cut by knife, the defrosting process can be considered completed.

4. Observe the below Defrost guide to achieve best performance.

Defrost guide

Steaks chop

- Shield thin end of chops or steaks with foil.
- Position the food with thinner parts in the centre in a single layer on a shallow dish. If pieces are stuck together, try to separate as soon as possible.

- When the oven beeps, it is to prompt you to turn over the food. Turn over, rearrange and shield the defrosted portions.

- Press Instant. Start to continue defrosting.

- After defrost time, stand covered with aluminium foil for 5-15 minutes.

Minced Beef

- Place frozen minced beef on a shallow dish. Shield edges.

- When the oven Beeps, it is to prompt you to turn over the food. Remove defrosted portions, turn over and shield edges with foil strips.

- Press Instant. Start to continue defrosting.

- After defrost time, stand covered with aluminium foil for 5-15 minutes.

Roast Meat (Beef/pork/lamb)

- Shield the edges with foil strips.

- Place joint with lean side face upwards (if possible) on a shallow dish.

- When the oven Beeps, it is to prompt you to turn over the food. Turn over, and shield the defrosted portions.

- Press Instant. Start to continue defrosting.

- After defrost time, stand covered with aluminium foil for 10-30 minutes.

Poultry

- Remove from original wrapper. Shield wing and leg tips with foil.

- Place breast side down on a shallow dish.

- When the oven Beeps, it is to prompt you to turn over the food. Turn over and shield the defrosted portions.

- Press Instant. Start to continue defrosting.

- After defrost time, stand covered with aluminium foil for 15-30 minutes.

Note: After standing run under cold water to remove giblets if necessary.

Chicken pieces (chicken wings and drumstick)

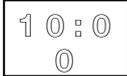
Depress	Display
Example: To defrost 0.2kg poultry	
1. After power-up, the colon flashes or press <b>Stop/Clear</b> button once	
2. Select the food kind by pressing <b>Defrost</b> button	
3. Set defrosting weight by turning the <b>Time. Weight/Auto cooking</b> knob	
4. Start cooking by pressing <b>Instant/ Start</b> , and LCD will count down to show running time.	
5. Half way during defrosting 3 beep sound will be heard two times to prompt you turn over the food. Open the door and turn over the food and shield the warm portion. Pressing <b>Instant/Start</b> button again to continue the defrosting. If you do not when an audible signal sounds, the defrosting cycle will continue until the time count down to 0.	

- Shield the exposed bone with foil.
- Place chicken pieces on a shallow dish.
- When the oven beeps, it is to prompt you to turn over the food. Turn over, rearrange and shield the defrosted portions.
- Press Instant. Start to continue defrosting.
- After defrost time, stand covered with aluminium foil for 5-30 minutes.

### 9. Auto cooking

The oven has default cooking menu for simple operation. When the LCD flash colon, turn the Time Weight/Auto cooking knob and LCD will cycle to show A - 01、 A - 02 ... A - 11 .

Choose the appropriate menu according to the food type and weight and strictly observe the directions of below table, otherwise the cooking effect will be largely influenced.

Depress	Display
Example: Steam 0.45kg fish	
1. After power-up, the colon flashes or press Stop/Clear button once	: :
2. Choose the appropriate menu by turning the Time. Weight/Auto cooking knob	A - 08 AUTOCOOKING
3. Start cooking by pressing Instant/Start , and LCD will count down to show running time.	6 : 3 0 AUTOCOOKING

### Auto cook table

NO	MENU	DISPLAY	MODE
A -01	AUTO COOK	0.05kg	Microwave
		0.1kg	Microwave
		0.15kg	Microwave
		0.20kg	Microwave
		0.20kg	Microwave
A -02	TEA/COFFEE	1 Cup	Microwave
		2 Cup	Microwave
		3 Cup	Microwave
A -03	BOILED POTATO	0.25kg	Microwave
A -04	POPCORN	1	Microwave
A -05	SOUP		
	TOMATO SOUP	1	Microwave
	PALAK SOUP	2	Microwave
	SWEET CORN SOUP	3	Microwave
A -06	SNACKS		
	OPEN GRILL SANDWICH	1	GRLL
	UPMA	2	Microwave
	PIZZA	3	Con
	IDLI / DHOKLA	4	Microwave

A -07	VEG MAIN - MENU			
	MASALA BHINDI	1	250 gm	Microwave
			500 gm	Microwave
	PANEER MUTTER MASALA	2	250 gm	Microwave
			500 gm	Microwave
	ALOO GOBI	3		Microwave
	TOMATO RICE	4		Microwave
	VEG. PULAV	5		Microwave
	VEG. KOLHAPURI	6	250 gm	Microwave
			500 gm	Microwave
	TANDOORI ALOO	7		Microwave
A -08	NON-VEG MAIN MENU			
	TANDOORI CHICKEN	1		COMBI -2
	CHICKEN LEGS	2	250 gm	COMBI -2
			500 gm	COMBI -2
	TANDOORI FISH	3		COMBI -2
	FISH PIECES	4	250gm	COMBI -2
			500 gm	COMBI -2
	CHICKEN CURRY	5	250 gm	Microwave
			500 gm	Microwave
	FISH CURRY	6	250 gm	Microwave
	500 gm		Microwave	
CHICKEN BIRYANI	7		Microwave	
A -09	CAKE/ COOKIES			
	SPONGE CAKE	1		Microwave
	COOKIES	2		CON
A -10	SWEETS			
	DUDHI HALWA	1		Microwave
	GAJAR HALWA	2		Microwave
	APPLE JAM	3		Microwave
	KESAR KHEER	4		Microwave
	BAUNDI	5		Microwave
	FRUIT CUSTURD	6		Microwave
A -11	HEALTH FOOD FOR KIDS			
	SABUDHA KHEER	1		Microwave
	SUJI KA HALWA	2		Microwave
	SPONJE WHEAT CAKE	3		Microwave
	FRUIT KHEER	4		Microwave
	MOONG DAL KI KHICHDI	5		Microwave
	APPLE STEW	6		Microwave
	MOTI PULAV	7		Microwave

Note:

1. The cook time above is based on the food which of the room temperature of 20-25°C. Results will vary for the food in different temperature.
2. The temperature, weight and shape of food will largely influence the cooking effect. If any deviation has been found to the factor noted on above menu, you can adjust the cooking time for best result.

## 10. Automatic starting (delayed function)

If you do not want the menu be started immediately, you can preset the cooking menu and time and the preset menu will be automatically started at your set time. The setting will consist of 2 steps: 1. Setting the current clock; 2. Setting the cooking menu and time.

Example: Now it is 12:00 clock, if you hope that the microwave oven will automatically start cooking with 100P microwave power for 9 minutes and 30 seconds at 14:20

Depress	Display	Depress	Display
1. Set the current time		2. Set the cooking menu and time	
1.1 Depress Preset. Clock button		2.1 Select cooking power by pressing Micro. Power button	
1.2 turning Time. Weight / Auto cooking button to set hours, and hours will be flashed		2.2 turning Time. Weight / Auto Cooking to set cooking time	
1.3 Depress Preset. Clock button again		2.3 To return to current clock. Hold Clock for 3 seconds, then a short beep sound will be heard	
1.4 turning Time. Weight / Auto cooking button to set minutes, and minutes will be flashed		3. Set the time you expect to start. Repeat the steps of 1.2, 1.3, 1.4	
1.5 Depress Preset. Clock or waiting for 5 seconds, and the numbers will go steady.		4. Depress Preset. Clock button to confirm the delayed menu. Now the program has been activated. And the menu will be Started at 14:20	
		5. You may check the preset starting time by depressing Preset. Clock button	

Note: Delayed function is not applicable for auto cook and auto defrost .

## 11. Multi-sequence cooking

To obtain best cooking result, some recipes call for different cook and time. You may program your personalized menu as follow:

Example: You want cook food with 100P microwave for 3 minutes then grill food for 9 minutes. This is 2 sequence setting.

Depress	Display	Depress	Display
1. 100P microwave for 3min		2. Grill food for 9min	
1.1 Press Micro Power button to select menu		2.1 Press Grill. Combibutton to select menu	
1.2 turning time. Weight / Auto cooking to set cooking time		2.2 turning time. Weight / Auto cooking to set cooking time	
		3. Start cooking by pressing Instant. Start	

When microwave power cooking is finished, microwave oven will begin grilling operation automatically.

Note: Max 4 sequence can be set per time repeat the steps 1.1, 1.2 if you like to set more.

## MICROWAVE COOKING TIPS

### 1) Arranging food

Place thicker areas toward outside of dish and the thinner meat in the center and spread them evenly. Do not overlap if possible.

### 2) Cooking time

Start cooking with the shorter period of time and extend it according to the actual need. Overcooking may result in smoking and burning.

### 3) Cover foods before cooking refer to the recipe

Use paper towels, microwave plastic wrap or a cover to cover food so that prevent spattering and help foods to cook evenly. (Helps keep oven clean).

### 4) Partial shielding of food

Use small pieces of aluminium foil to cover thin areas of meats or poultry to avoid overcooking.

### 5) Stir foods

From outside to center of dish once or twice during cooking, if possible.

### 6) Turn foods

Foods such as chicken, hamburgers or steaks should be turned over once during cooking.

### 7) Rearrange foods

Please change the positions of food in half way during cooking such as: from top to bottom and from the center of the dish to the outside.

### 8) Allow standing time

After cooking ensure adequate standing time. Remove food from oven and stir if possible. Cover for standing time which allows the food to finish cooking without overcooking.

### 9) Check for doneness

Observe the food color and hardness to determine whether the food is cooked. Doneness

signs include:

- Steams throughout food, not just at edge part.
- Joints of Poultry move easily.
- Pork and poultry show no evidence of blood.
- Fish is opaque and flakes easily with a fork.

### 10) Condensation

It is a normal case of microwave cooking. The humidity and moisture of food will influence the amount of moisture in the oven. Generally, covered foods will not cause as much condensation as uncovered foods. Ensure that the ventilation openings are not blocked.

### 11) Microwave safe plastic wrap

For cooking food with high fat content, do not bring the wrap in contact with the food as it may melt.

### 12) Microwave safe plastic cookware

Some microwave safe plastic cookware are not suitable for cooking foods with high fat and sugar content.

## 40 AUTO COOK MENU RECIPES- for CONVECTION RANGE

### **A-1. AUTO - REHEAT**

1.This function is to reheat food .Any cooked food with cover .  
(Rice, Dal ,Veg.etc)

2.Select Menu & Press Start.

### **A -2 TEA/COFFEE**

Auto setting for 1, 2 & 3 cups.

*ForTea/Coffee*

#### ***Ingredient***

Water

Sugar

Coffee/tea

Milk

#### **Method:**

- 1) In a Microwave safe bowl (Without Lid), Add all ingredient & mix well.
- 2) Set the Auto Cook Menu & Press Start.

### **A-3 BOILED POTATO**

#### ***Ingredient***

Potato 250 gm (cut into 2 pieces)

Water - 4 to 5 cup or as required

**Method:**

- 1) In a Microwave safe bowl (Without Lid), Add all ingredient .
- 2) Set the Auto Cook menu & press start.

**A-4 POPCORN**

***Ingredients:***

Dry corn 100 gms

Butter 1 tbsp

Salt To taste

**Method:**

- 1) In a Microwave Safe bowl (with lid), add all ingredients and mix well.
- 2) Set the Auto Cook menu & press start.

**A-5 SOUPS**

**1.TOMATO SOUPS**

***Ingredients:***

1 Cup Tomato puree

3 Cups Water or as required

2 tbsp Butter

2tbsp Corn flour (mix in ½ cup water)

Sugar, Red chill powder , salt , pepper- to taste

1 tbsp Fresh cream (for garnish)

**Method :**

- 1) In a Microwave Safe bowl (with lid), Add all ingredient and mix well.
- 2) Set the Auto Cook menu & press start, stir in between.
- 3) Garnish with fresh cream.
- 4) Serve Hot.

**2.PALAK SOUP.**

**Ingredients:**

1 ¼ Cup Palak - Spinach (cook & paste)

1 Onion (cook & paste)

2 cup water or as required

1 cup Milk

2tbsp Corn Flour (mix in ½ cup water)

1tbsp Butter

Sugar, garlic , gingerpaste, pepper,lemon juice,jeera powder & salt - to taste

For garnish-

1-2 tbsp cream .

**Method:**

- 1.In a Microwave Safe bowl (without lid),add all ingredient and mix well.
- 2) Set the Auto Cook menu & press start, stir in between.
- 3) Garnish with fresh cream.
- 4) Serve Hot.

### ***3.SWEET CORN SOUP***

#### **Ingredients:**

½ Cup Sweet Corn cream style or 1 fresh corn (grated)

3 cups water

3tbsp Corn flour (mix in ½ cup water)

1 tbsp Soya Sauce

Sugar, Salt, Black pepper to taste

1tbsp coriander leaves (chopped)

#### **Method :**

1. In a Microwave Safe bowl add all ingredient and mix well.
2. Set the Auto Cook Menu & press start . Stir in between.
3. Serve Hot.

### **A-6 SNACKES**

#### **1. OPEN GRILL SANDWITCH**

##### ***Ingredients:***

Bread            1 Slices

Butter            1tbsp

Tomato Sauce   3-4 tbsp

Onion            1 (chopped)

Tomoto           1 (chopped)

Capsicum        1 (chopped)

Cheese           200 gms (grated)

Salt, pepper      To taste

**Method:**

- 1 Apply little butter on both the sided of bread.
- 2 Spread sauce on one side of the bread and Put the vegetable.
- 3 Sprinkle grated cheese on top and set the auto cook menu & press start.

**2. PIZZA.**

**Ingredients:-**

1 medium pizza base

For Topping :-

Onion (chopped)      ¼ cup

Tomatoes ( chopped) ¼ cup

Capsicum (chopped) 2tbsp

Tomato sauce          3 tbsp

Pizza cheese(shredded) ½ cup

Salt                      To taste

**Method:-**

1. Spread tomato sauce on pizza base.
2. Now spread the all veg topping on pizza base.
3. Sprinkle grated pizza cheese at the top of pizza.
4. In a microwave safe dish, place pizza and set the Auto Cook menu &press start.

### **3. UPMA**

#### ***Ingredients :***

1 Cup Suji (roasted)

1 Onion (chopped)

1 tbsp Fresh Coconut grated (for the garnishing)

1 tomato chopped

1 tbsp coriander leaves

2 tbsp oil

5-6 Curry Leaves

A pinch of hing

1 tbsp roasted peanuts

2 ½ Cup water as required

Green chillie paste to taste

Sugar, Salt to taste

#### **Method :**

- 1) In a microwave safe bowl, add all ingredients and mix well
- 2) Set the auto cook menu &press start stir in between.
- 3) Garnish with fresh coconut & Serve Hot.

## 5. IDLI

### **Ingredients:**

Idli batter

### **Method:**

- 1) Pour warm water into the 2.5 ltr bowl.
- 2) Pour batter into the idli plates given in the idli stand & keep inside the bowl & cover it with the lid.
- 3) Set the Auto Cook menu & press start.

## **A-7 VEG–MAIN COURSE**

### **1.BHINDI MASALA**

#### ***Ingredients:***

Bhindi (Ladies fingers) : 250 gms or 500 gms

Grated fresh coconut : ½ cup

Corianders Chopped : 2 ½ tbsp

Oil : 1-2 tbsp

Chill powder,dhania powder,Sugar & salt to taste

#### **Method:**

- 1) In a Microwave Safe bowl, and mix ingredients well and sprinkle 1 tbsp of water over them.
- 2) Set the Auto Cook menu & press start
  - Stir in between.
- 3)Serve hot with chapati.

## **2.PANEER MUTTER MASALA**

### **Ingredients:**

Paneer & Green Peas	250 gms	500 gms
Water	As required	As required
Oil	3 tbsp	4 tbsp
Sugar,Salt	To taste	To taste

Coriander leaves for garnishing

To be ground into paste

1-2 Onion,2-4 tomato ,fresh coconuts grated to taste , 2 cloves garlic, 2 tbsp dhania-jeera seeds,whole red chillies 1-2 or to teste.

### **Method:**

- 1) In a Microwave Safe bowl, add all ingredients and pasted ,mix well.
- 2) Set the Auto Cook Menu & press start.

- stir in between.

Garnish with Coriander leaves.

Serve hot.

## **3.ALOO GOBI.**

### ***Ingredients :***

250gm cabbage grated

1 big aloo (peel &chopped)

¼ Cup fresh coconut grated

5-6 Curry leaves

2 tsp oil

1 tsp jeera roasted

Green chilli paste ,sugar,Salt to taste

Coriander leaves for garnish

**Method:**

1) In a Microwave Safe bowl, add all ingredients and mix well

2) Set the Auto Cook menu , press start,stir in between.

3) Garnish with coriander leaves.

Serve Hot.

**4.TOMATO RICE**

**Ingredients :**

1 cup Basmati Rice (soak for 30 mins)

1 Big Onion Chopped

Red Chilli Powder,Garam Masala powder,Sugar & Salt to taste

5-6 curry leaves

$\frac{3}{4}$  cup tomato puree.

2tbsp oil

2  $\frac{1}{2}$  cup water as required

2-3 dry red chilli (chopped)

A pinch of (hing) asafetida

**Method :**

1) In Microwave Safe bowl (without lid), add all ingredient & mix well.

2) Set the auto cook menu &press start and stir in between.

3) Serve hot.

## 5. VEG PULAV

### Ingredients:

Rice : 1 cup (150gms)  
Mix veg : ½ cup (Carrots ,beans, mutter)  
Water : 2 ½ cup  
Dry fruits: 4tbsp  
Pulav Masala : 2tbsp  
Oil : 3tbsp  
Salt : To taste.

### Method:

- 1) Wash and soak rice for 30 mins. Cut the veg into small pieces.
- 2) In a Microwave Safe bowl (without lid), add all ingredients and mix well.
- 3) Set the Auto Cook menu & press start.  
Stir in between.

## 6. VEG KOLHAPURI

### Ingredients :

250-500 gms Veg. (Carrot, cauliflower, French beans, Green Peas, Potatoes)

3-4 tomatoes chopped or to taste.

2-3 tbsp oil

3-4 Cup Water as required

1 tbsp coriander chopped

Garam masala , Salt to taste

### To paste :

Cup fresh coconut, Dry red chillies to taste , 1 -2 onion, 1-2 tbsp til

5 cloves garlic, 2-3 tbsp khus khus, 20 mm ginger

**Method:**

1) In a Microwave Safe bowl, add all ingredients and mix well

2) Set the Auto cook menu & press start.

Stir in between.

3) Serve Hot.

**7.TANDOORI ALOO**

**Ingredients:**

250 gm baby potato (peel & fork all aside)

2 tbsp oil

1 tbsp cream

2 -3 tbsp water

1-2 tbsp Kasuri methi ( dry leaves)

Salt, cloves power ,kasmiri chill power to taste

**Method**

1) In a Microwave Safe Bowl(with lid ), add all ingredients and mix well

2) Set the auto cook menu & press start.

stir in between.

3) Serve Hot.

**A-8 NON-VEG MAIN COURSE**

**1.TANDOORI CHICKEN**

**Ingredients:**

Chicken

For Marinate:Garlic-ginger paste ,Garam Masala,,Lemon Juice,Red chili powder, salt to taste,Red color few (optional)

**Method:**

- 1) Wash the chicken and make diagonal-incisions all over it.
- 2) Mix all ingredients of the marinade. Add the chicken and Refrigerate for 1 hour.
- 3) Put the chicken into the microwave safe bowl (covered) and set the Auto cook menu & press start.

- Turn in between.
- Now brush with oil and grill for 7-8 mins.
- Turn in between.

**2.CHICKEN LEGS**

***Ingredients:***

Chicken Wing 250 – 500 gm

For Marinade

Garlic-ginger Garam Masala ,Lemon Juice, Red chili powder To taste

Salt To taste

Red color Few (optional)

**Method:**

- 1) Wash the chicken wing and make diagonal-incisions all over it.
- 2) Mix all ingredients of the marinade. Add the chicken wing and Refrigerate for 1 hour.
- 3) Put the chicken wing into the Microwave Safe bowl (covered) and set the Auto Cook menu & press start
  - Turn in between.
  - Now brush with oil and grill for 6-7 mins.
  - Turn in between.

### **3.TANDOORI FISH**

#### **Ingredients:**

Fish

1 tbsp oil

For Marinate:

Ginger paste ,Lemon Juice ,Garlic Paste to taste

garam Masala ,Red chilli powder To taste

Salt To taste

#### **Method:**

- 1) Wash the fish and dry it and give incision all over it.
- 2) In a bowl mix together all ingredients except oil and keep the fish in it or an hour.
- 3) Brush the marinated fish with the oil and set the auto cook menu & press start. Turn in between. Now grill for 7 -8 min. Till golden in color.

### **4. FISH PIECES**

#### **Ingredients:**

Fish pieces 250 -500 gms

1- 2 tbsp oil

For Marinate

Garlic-ginger ,paste ,Garam Masala,Lemon Juice , chili powder & salt- to taste.

Red color Few drops (Optional)

**Method:**

- 1) Wash the fish pieces and dry it and give incision all over it.
  - 2) In a bowl mix together all ingredients except oil and keep the fish in it for an hour.
  - 3) Brush the marinated fish pieces with the oil and set the auto cook menu. & press start. Turn in between.
- Now grill for 7 -8 min. Till golden in color.

**5.CHICKEN CURRY**

**Ingredient :**

250-500 gms chicken cut into pieces.

Turmeric powder, kokam, Salt to taste

2 -3tbsp -oil

For paste : 3-4 onion, 2tbsp garlic- ginger paste, 2-3tomato, 2-3tsp coriander -cumin seeds  
Chicken - curry powder, 2-3 dry red chillies or tested.

**Method :**

- 1) In Microwave Safe bowl (with out lid), add oil, paste and chicken, turmeric-powder  
kokam ,salt, water & Mix well.
- 2) Set the Auto Cook menu . Press start and stir in between.
- 3) Serve hot with Rice.

**6.FISH CURRY**

**Ingredient :**

250-500 gms fish cut into pieces.

Turmeric powder, kokam ,Salt to taste

2 -3tbsp -oil

For paste : 3-4 onion, 2tbsp garlic- ginger paste, 2-3tomato, 2-3 tsp coriander -cumin seeds

Fish - curry powder,2-3 dry red chillies or tested.

**Method :**

- 1) In Microwave Safe bowl (with out lid), add oil,paste and chicken, tuemic powder , Kokam, salt,water & Mix well.
- 2) Set the auto cook menu ,press start and stir in between.
- 3) Serve hot with rice.

**7.CHICKEN BIRYANI**

**Ingredients:**

Basmati Rice	150 grams
Chicken (Boneless Cut into pieces)	6- 8
Onion slice	1 medium
Ginger –garlic paste	1 tbsp
Water	2 1/2 cup or requiried
Tomato, puree	3/4 cup
Salt ,black pepper powder	To taste
Turmeric powder ,Garam masala	To taste
Cloves	4
Cinnamon sticks	2
Bay leaves	2
Pepper corns	2-3
Oil	2 tbsp
Almonds ,Cashew nuts , Raisins ,saffron	to taste

**Method:**

- 1) Wash and soak Rice for 30 mins.
  - 2) In a Microwave Safe bowl (without lid), add all ingredients and mix well.
  - 3) Set the Auto Cook menu & press Start.
- Stir in between.

**A-9**

**1.SPONGE CHOCOLATE CAKE**

**Ingredient:**

Eggs 3

Butter 100 gms

Flour 1 cup

Sugar powder 1 cup

Drinking chocolate powder 2 tbsp

Coco powder ½ tbsp

Baking powder 1tsp

Water /milk as required

**Method:**

- 1) Sieve flour,coco powder,Drinking chocolate powder and baking powder together in a bowl. Keep aside.
- 2) Beat Butter, Sugar and egg till fluffy and creamy in another bowl.
- 3) Slowly mix the sieved flour mixture and the beaten eggs.
- 4) And water to make smooth batter.
- 5) Pour the cake batter into the greased cake bowl(with out lid) and Set the Auto Cook menu.

6. Press start.

## **2. COOKIES/NANKHATAI**

### **Ingredients:**

Flour (maida) 130 gms

Co co powder 20 gms

Sugar powder 100 gms

Vanaspati ghee 100 gms

### **Method:-**

- 1) Sieve flour and co co powder in a bowl.
- 2) Beat vanaspati ghee and sugar until light and fluffy.
- 3) Mix all the ingredients together and knead a soft dough. Roll the dough and cut into cookies with the of biscuit cutter.

If you don't have the cutter, Simply roll out small balls form the dough. Pierce them with help of a fork to make an impression, place biscuits at least 5 cm apart giving enough spaces for expansion.

- ❖ Grease the Microwave safe dish and place cookies on it and set the Auto Cook menu and press start.

## **A-10 SWEETS**

### **1.DHOODHI HALWA**

#### **Ingredients :**

1 Big dhoodhi (peeled and grieved)

5 tbsp sugar or to taste

¼ tsp elachi powder

1 cup milk

2-3 tbsp ghee

6-8 tbsp khoya

2 tbsp mix dry fruit (chopped)

**Method:**

1) In Microwave safe bowl (without lid) add all ingredient & mix well.

2) Set the Auto cook menu & press start.

3) Stir in between.

**2. GAJAR HALWA**

**Ingredients:**

Carrots grated            250 gms

Milk                            1 cup(150 ml)

Sugar                            5 tbsp

Elachi powder                ¼ tbsp

Melted ghee                 2-3 tbsp

Mava                            5-6 tbsp

For the garnishing:

Sliced pistachions and cashew nuts            1 tbsp

Varg Sliver    1

**Method:**

1) In Microwave safe bow(with out lid), add mix ingredients and mix well.

2) Set the Auto Cook menu & press start.

3) Stir in between.

4) Garnish with the sliced Pistachios, Cashew Nuts and Varg.

### **3. APPLE JAM**

#### **Ingredients:**

Big apple                      3-4 (pasted)  
Lemon juice                    2-3 tbsp  
Water                            1 cup  
Sugar, Cardamom powder      to taste

#### **Method:**

- 1) In a microwave safe bowl {without lid}, add all mix Ingredients and mix well.
  - 2) Set the auto cook menu & press Start .
- And stir it after every 3-4 mins.

### **4. SWEET KESAR KHEER**

#### **Ingredients:**

Long rice or Nylon Noodles      50 gms  
Milk                              2-3 cups  
Condensed Milk                    ½ cups  
Elachi powder, Sugar, Dry fruit  
Saffron                              To taste

#### **Method:**

- 1) Wash and drain the Rice. (Soak for 30 min)
  - 2) In a Microwave safe bowl (with lid), mix ingredients.
  - 3) Set the Auto Cook Menu & press Start.
- Stir in between.
- 4) Serve hot.

## **5.BASUNDI**

### **Ingredients :**

3 Cup Milk (600 ml.)

110 Gm Sugar or to taste

1tsp Milk Masala Powder

1tbsp Mix Dry Fruit (Chopped)

### **Method:**

- 1) In a Microwave Safe big bowl (without lid) mix all ingredient well.
- 2) Set the Auto Cook Menu & press Start.
- 3) Stir in between.

## **6.FRUIT CUSTURD**

### **Ingredients :**

500ml Milk

100 gms Sugar

3tbsp Custurd Powder (50gm).

1Cup Fruit (according to taste)

### **Method :**

- 1) In a Microwave safe bowl,add mix all ingredients (except fruit) and mix well.
- 2) Set Auto Cook Menu & press Start.
- 3) Stir in between.
- 4) When it gets cool, add fruits & set in refrigerator.
- 5) Serve chilled.

## **A-11 HEALTH FOOD FOR KIDS**

### **1.SABOODANA KHEER**

#### **Ingredients :**

1 ¼ Cup milk

2 tbsp saboodana (soak for 30 min)

2 tbsp sugar

#### **Method :**

- 1) In Microwave Safe bowl (without lid) add all ingredient & mix well.
- 2) Set the auto cook menu press start and stir in between.
- 3) Serve lukewarm.

### **2 SUJI KA HALWA**

#### **Ingredients:**

Roasted suji      1 cup (100gms)

Sugar              1cup

Water or milk    2 ½ cup

Ghee                4 tbsp

Dry fruit          3-4 tbsp

Cardamom powder    1 tsp

#### **Method**

- 1) In a Microwave Bowl, mix ingredients.
- 2) Set the Auto Cook Menu & Press Start.
- 3) Stir in between.

### **3 SPONGE WHEAT CAKE**

#### **Ingredient:**

Eggs	3 nos
Butter	100 gms
Wheat (atta)	1 cup
Sugar powder	1 cup
Drinking chocolate powder	2 tbsp
Coco powder	½ tbsp
Baking powder	1tsp
Water /milk	as required

#### **Method:**

- 1) Sieve wheat(atta) , coco powder, drinking chocolate powder, and baking powder together in a bowl. Keep aside.
- 2) Beat Butter, Sugar and Egg till fluffy and creamy in another bowl.
- 3) Slowly mix the sieved flour mixture and the beaten eggs.
- 4) Add water to make smooth batter.
- 5) Pour the cake batter into the greased cake bowl (without lid) and Set the Auto Cook Menu.
- 6) Press start.

#### **4. FRUIT KHEER (APPLE–CAORRT KHEER)**

##### **Ingredients :**

1 Apple (peeled and grated)

3 tbsp grated carrot

1tsp sugar

1 1/2 cup milk

2 tbsp sweet condensed milk

½ tsp milk masala powder.

##### **Method :**

1) In Microwave Safe bowl (without lid) add all ingredient & mix well.

2) Set the Auto Cook menu & press start and stir in between.

3) Serve lukewarm.

#### **5 MOONG DAL KI KHICHDI**

##### **Ingredient :**

1 cup rice (Rice and Dal soak in 30 min)

¼ cup moong dal

4 cups water/as required.

2 tbsp ghee

¼ tsp turmeric powder

2-3 cloves

1 Cinnamon stick

2 Black cardamoms

2-3 bay leaves

A pinch of asafoetia

Salt ,Black pepper powder to taste

**Method :**

- 1) In a Microwave Safe big bowl add all ingredient and mix well.
- 2) Set the Auto Cook Menu & press start stir in between.
- 3) Serve hot with kadhi.

**6.APPLE STEW**

**Ingredients :**

1 Apple (peeled and paste)

2tbsp jaggery (crushed)/sugar

1 cup Milk/Water.

**Method :**

- 1) In Microwave Safe bowl (without lid), add all ingredient & mix well.
- 2) Set the auto cook menu, press start and stir in between.
- 3) Serve lukewarm and cold.

## **7.MOTI PULAV**

### **Ingredients :**

1 Cup basmati rice (soak in 30 mins)

2 ½ cup water

4 tbsp fresh corn

1 tbsp kaju(cut into small pieces)

1 tbsp pulav masala

2 tbsp ghee

Salt to taste

### **Mehtod:**

- 1) In Microwave Safe Bowl (without lid)add all ingredient & mix well.
- 2) Set the Auto Cook menu & press start and stir in between.
- 3) Serve lukewarm.

## CLEANING AND MAINTENANCE

The oven should be cleaned regularly and any food deposits removed.

Suggest you perform below steps after every time use.

Never use hard detergent, gasoline, abrasive powder or metal brush to clean any part of the appliance.

Clean the oven at regular intervals

Disconnect the power supply cord before cleaning. And if possible leave the door open to inactivate the oven during cleaning.

Exterior:

The outside may be cleaned wipe with a soft and damp cloth. Avoid the use of harsh abrasive cleaners.

Door:

Wipe the door and window on both sides, the door seals and adjacent parts frequently with a damp cloth to remove any spills or splatters. Do not use abrasive cleaners.

Control panel:

Care should be taken in cleaning the control panel. Wipe the panel with a cloth dampened slightly. Do not scrub or use any sort of chemical cleaners.

Interior walls:

To clean the interior surfaces, wipe with a soft and damp cloth for hygienic reasons. After use wipe the waveguide cover in the oven with a soft damp cloth to remove any food splashed. Buildup splashes may overheat and begin to smoke or catch fire. Do not remove the waveguide cover. Do not use a commercial oven cleaner, abrasive or harsh cleaners and scouring pads on any part of your microwave oven. Never spray oven cleaners directly onto any part of your oven.

Turntable/ Rotating ring/Rotating axis

Wash with mild soapy water and dry thoroughly.

TIP: When the microwave oven has been used for a long time, there may be some strange odors exist in oven, Following 3 methods can get rid of them:

1. Place several lemon slices in a cup, then heat with high power for 2-3 min.
2. Place a cup of red tea in oven, then heat with high power.
3. Put some orange peel into oven, then heat them with high power for 1 minute.

## SERVICING

Warning: it is hazardous for anyone, other than a qualified service technician, to carry out any service for repairing operation which involves removal of any cover which gives protection against exposure to microwave energy.

Caution: MICROWAVE RADIATION

Do not become exposed to radiation from the microwave generator or other parts conducting microwave energy.

During servicing below listed parts are liable to be removed and give access to potentials above 250V to earth.

1. Magnetron
2. High voltage transformer
3. High voltage capacitor
4. High voltage diode
5. High voltage fuse

Below listed condition may cause undue microwave exposure during servicing.

1. Unproper fitting of magnetron.
2. Unproper matching of Door interlock, door hinge and door.
3. Unproper fitting of switch support.
4. Door, Door seal or enclosure has been damage.



Customer Name..... Address.....

Serial No..... Date of purchase..... Model No.....

Dealer Seal.....

## HAIER WARRANTY

HAIER APPLIANCES (INDIA) PVT. LTD. (hereinafter referred to as “the Company”) hereby offers the following warranty to the original domestic purchaser commencing from the date of the purchase. The Company, at its sole discretion, will free of charge repair or replace any defective part or parts which prove to be defective in workmanship and/or materials and not due to abnormal or improper usage.

### CONDITIONS OF WARRANTY

- 1) This warranty will automatically terminate on the expiry of the warranty period from the date of delivery.
- 2) The Company is not liable for any delay in servicing due to reasons beyond the control of the Company or any of its authorised service centres.
- 3) Parts replaced or repaired under this warranty are warranted throughout the remaining of the original warranty period.
- 4) It is entirely left to the Company’s discretion to repair/replace parts at the site of installation or at the authorised service centre of the Company.
- 5) This warranty shall be strictly limited to the repairs or replacement of defective parts specified in the warranty. This warranty shall not cover any consequential or resulting liability.
- 6) This warranty shall not, in any case, extend towards payment of any monetary consideration whatsoever or replacement or return of the product.
- 7) The Company may repair/supply parts free of cost during the warranty period. This warranty does not cover any Excise duty, Central or Sales tax, Octroi and other local taxes or levies on the components/parts.
- 8) The parts shall be replaced by functionally operating equivalent material only and not with brand new ones and are likely to be different from the one originally fitted. The parts thus removed shall be taken back by the Company.
- 9) The Company reserves the right to retain any part or component replaced at its sole discretion during the warranty period.
- 10) In no event the Company or its authorised service centre be liable for any consequential damages or resulting liability, damage or loss arising directly or indirectly out of any defect in the product.
- 11) This warranty is not valid in case of the following events:
  - a) If the Product has been Installed/ Serviced/ Repaired/ Opened or Tampered by any unauthorised personnel.
  - b) If defects arise/ caused by accidents, alteration, misuse, neglect, substitution of original components with spurious/ non-genuine components, attacked by household pest / rodents, fire, flood, earthquake, lightning and/ or any other act of God/ natural calamities.
  - c) The product is shifted outside India.
- 12) For any service under this warranty beyond city/ town/ municipal limits from the Company/ authorised service centre, a fixed charge of Rs. 50 will be collected from the customer in addition to the actual to and fro charges by the shortest route.
- 13) Any change of location or change in the ownership during the warranty period must be intimated in writing to the Company.
- 14) The Company’s employees or its authorised representatives have no authority to vary the terms of this warranty.
- 15) This warranty is effected in New Delhi and claims, if any, shall be made only before the courts having jurisdiction in New Delhi and no claim shall be made against the Company outside New Delhi notwithstanding that the Appliance may have been sold or delivered elsewhere.

Product	Warranty	
	Period	Parts not covered
Colour TV	12 Months	Remote, Cabinet
Refrigerator	Comprehensive: 12 Months Compressor: 60 Months	Plastic, Glassware, Light Bulb
Washing Machine	Comprehensive: 24 Months Motor: 60 Months	Top Lid, Outer Casing
Airconditioner	Comprehensive: 12 Months Compressor: 60 Months	Air Filter, Front Grill
Microwave	Product: 12 Months Magnetron: 36 Months	Glass, Turn table, Bulb
Dishwasher	24 Months	
Cloth Dryer	12 Months	
DVD	12 Months	

HAIER APPLIANCES (INDIA) PVT. LTD., B-1/A-14, Mohan Co-operative Industrial Estate, New Delhi-44  
Ph: 30674000/5000. Fax: 011-26971562



Customer Name..... Address.....

Serial No..... Date of purchase..... Model No.....

Dealer Seal.....



# Haier

**Haier Appliances (India) Pvt Ltd.**  
**B1/A-14, Mohan Co-op Ind Estate, Mathura Road, New Delhi 110044**  
**Tel: 011-39496000/30674000, Fax:011-26971562**  
**[www.haierindia.com](http://www.haierindia.com)**